

# *Halcyon Precision Inflator*

## *Owner's Manual*

V2.0

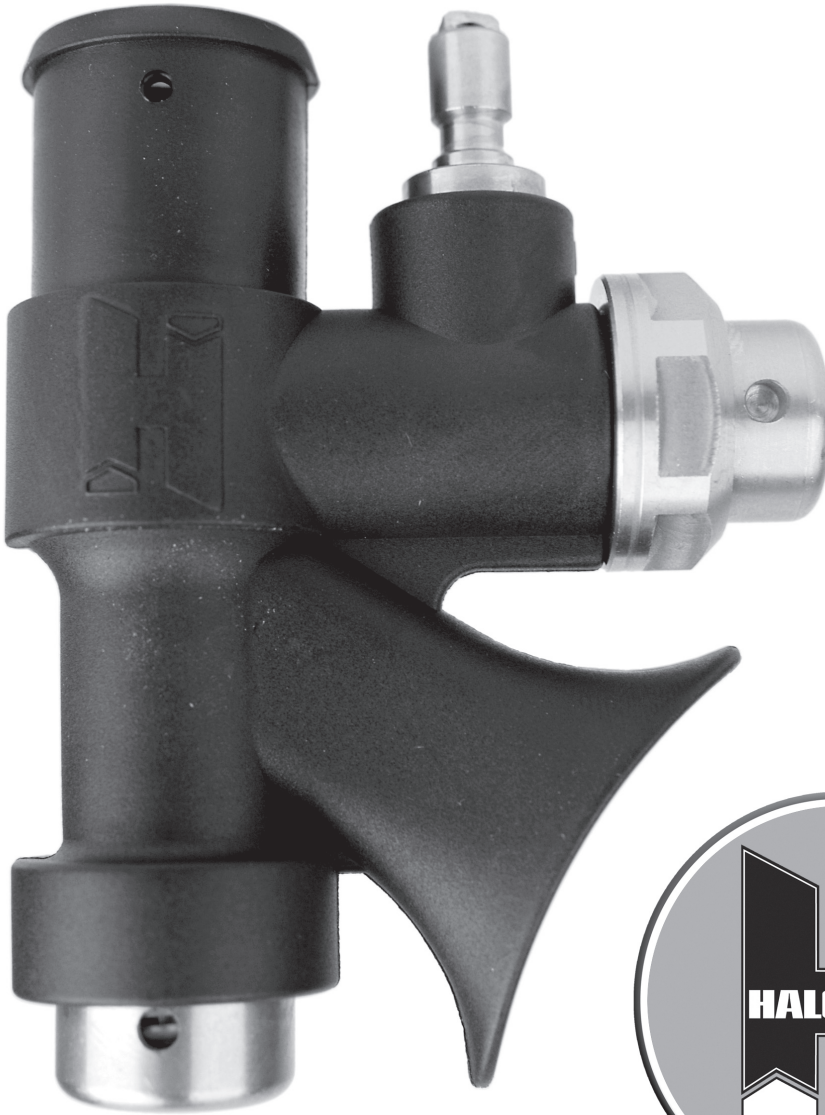

## **Warranty Information**

All warranty requests must be accompanied by proof of original purchase from an Authorized Halcyon Dealer. Be sure to save your sales receipt, and present it whenever returning your Halcyon Precision Inflator for warranty service. All claims will need to be accompanied by a Return Material Authorization Number (RMA#). RMA # can be obtained by contacting Halcyon Technical Services at 1-800-425-2966.

HALCYON warrants, to the original purchaser only, that the HALCYON Precision Inflator will be free of defects in materials and/or craftsmanship under normal diving use for one year from the date of purchase, provided proper care is performed on all materials as described within this manual. Should your HALCYON Precision Inflator prove to be defective for any reason (other than those listed in the limitations section below) it will be repaired or replaced (at HALCYON's discretion) free of charge excluding shipping and handling charges. All correspondence concerning this warranty must be accompanied by a copy of the original sales receipt. Repair or replacement is HALCYON's only responsibility and your only remedy under this warranty.

**WARNING:** It is dangerous to use the equipment covered by this warranty without proper scuba certification. Therefore, use of these products by an untrained person renders any and all warranties null and void. Use of scuba equipment by anyone who is not a certified diver, or receiving training through a recognized certification agency, shall render void all warranties, expressed or implied.

**ALL WARRANTIES, INCLUDING, BUT NOT LIMITED TO, IMPLIED WARRANTIES OF MERCHANTABILITY AND FITNESS FOR A PARTICULAR PURPOSE ARE LIMITED IN DURATION TO A PERIOD ENDING ONE YEAR FROM THE DATE OF PURCHASE.**

Some states in the U.S. and certain foreign countries do not allow limitations on the duration of implied warranties, so this may not apply to you. This warranty gives you specific legal rights. You may have rights which vary from state to state and country to country.

**HALCYON MANUFACTURING DISCLAIMS AND EXCLUDES ANY LIABILITY FOR INCIDENTAL OR CONSEQUENTIAL DAMAGES. SOME STATES IN THE U.S. AND CERTAIN FOREIGN COUNTRIES DO NOT ALLOW EXCLUSIONS OR LIMITATIONS OF LIABILITY FOR INCIDENTAL OR CONSEQUENTIAL DAMAGES, SO THIS MAY NOT APPLY TO YOU.**

### **Limitations**

The following restrictions apply to this warranty:

1. This warranty extends to all power inflator parts.
2. This warranty does not extend to discoloration or blemishes caused by chemical attack; including prolonged exposure to chlorine and/or salt water.
3. This warranty does not extend to damages caused by improper use, improper maintenance, neglect, unauthorized repairs, modifications, accidents, fire, or casualty.
4. Cosmetic damage, such as scratches, fraying, and nicks are not covered by this warranty.
5. This warranty does not extend to equipment used for rental, commercial, governmental or military purposes.
6. This warranty covers products purchased in the United States. For warranties that may apply elsewhere, please contact your local representative.
7. Failure to meet any of the above requirements will render the warranty null and void.

The Halcyon Precision Inflator is another DIR Dive System innovation providing excellent performance under any demand. The Halcyon Precision Inflator has been designed to be easily serviced by a technician, allowing many years of reliable operation. This manual will provide proper installation and maintenance for your new inflator.

## Installing the Halcyon inflator on your BC

- 1) Remove the old inflator from the corrugated hose on the buoyancy control device. Thoroughly clean the inside circumference of the corrugated hose, ensuring all adhesive residue is removed. **DO NOT use a caustic cleaning solvent such as bleach or mineral spirits.** Thoroughly dry corrugated hose.
- 2) Prep the Halcyon inflator for installation by cleaning and drying the hose attachment barb on the inflator barrel.
- 3) Using a room temperature vulcanizing (RTV) silicone adhesive/sealant, lightly coat cleansed area of the inflator. If an RTV silicone adhesive cannot be found, a silicone sealant that is approved for aquarium use is an acceptable alternative.
- 4) Push the inflator into the corrugated hose as shown in Figure 1. Wipe away excess sealant with a clean, lint-free towel.
- 5) Place clamp around the hose as shown in Figure 2. Final position of clamp should be opposite the inflator quick-disconnect nipple.
- 6) Pressing the two ends of the clamp together, screw the bolt into the acorn nut to secure the clamp. Clamp is fully seated when bolt reaches its end of travel.



Figure 1

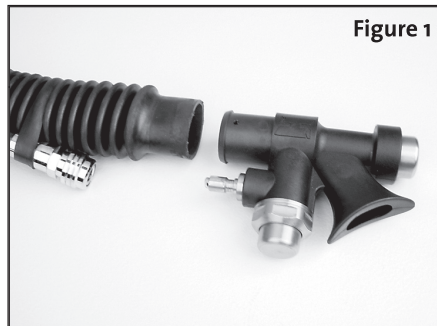
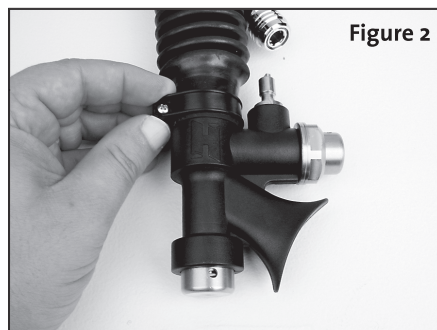

Figure 2



Final installation of the inflator should look like Figure 2.

## Maintenance

The Halcyon Precision Inflator is designed to be serviced by an authorized dealer. Halcyon recommends periodic maintenance of your inflator, similar to that of regulator maintenance. Halcyon recommends that the inflator should be serviced at least once a year as a minimum, or every six months under heavy use. If your inflator exhibits either sticking buttons or is leaking air (either into bladder or out dump), discontinue use until the inflator can be serviced.

### General tools required for service

- Adjustable wrench or 1 inch (2 ½ mm) box head wrench and duckbill pliers
- Medium size flat head screwdriver
- Small size flat head screwdriver
- 1/8<sup>th</sup> inch hex key
- Medium strength threadlocker adhesive (Loctite releasable/blue or similar)
- Torque wrench (optional)

### Parts needed

Halcyon Precision Inflator O-ring Kit (Part# 14.060.109)

### Disassembly



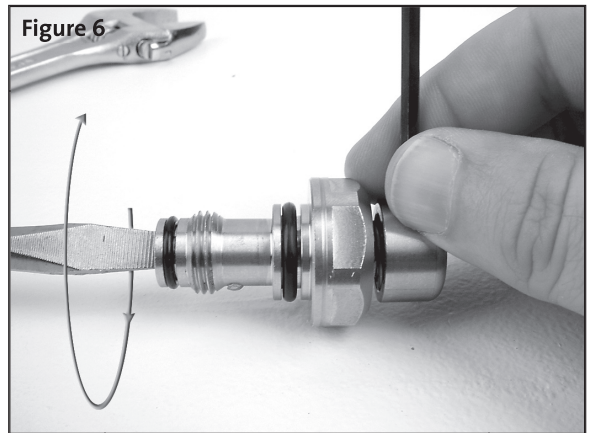
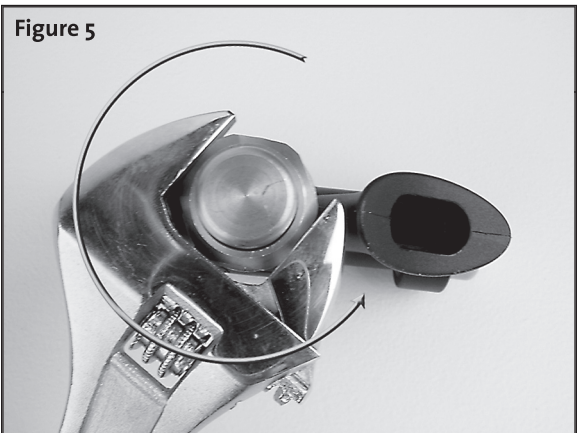
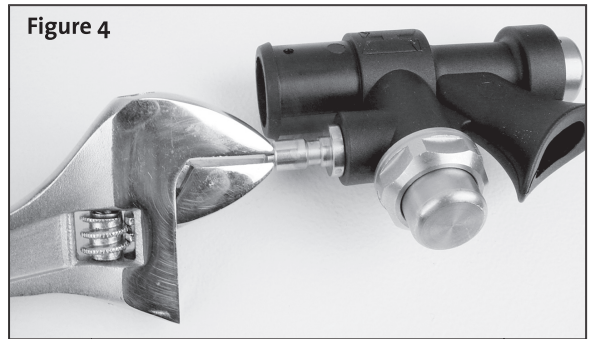
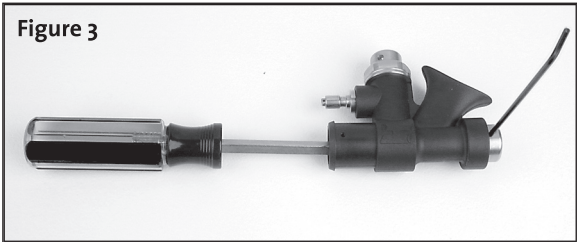
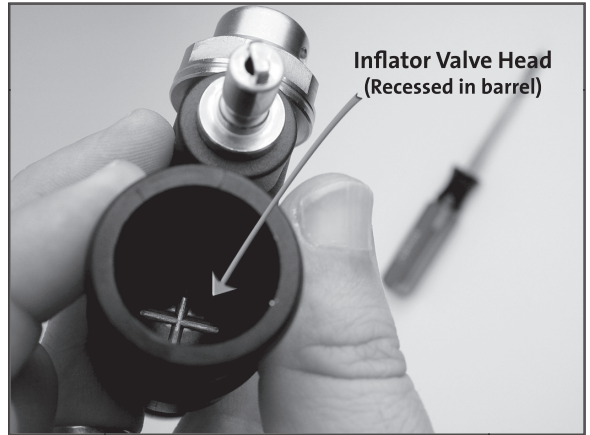
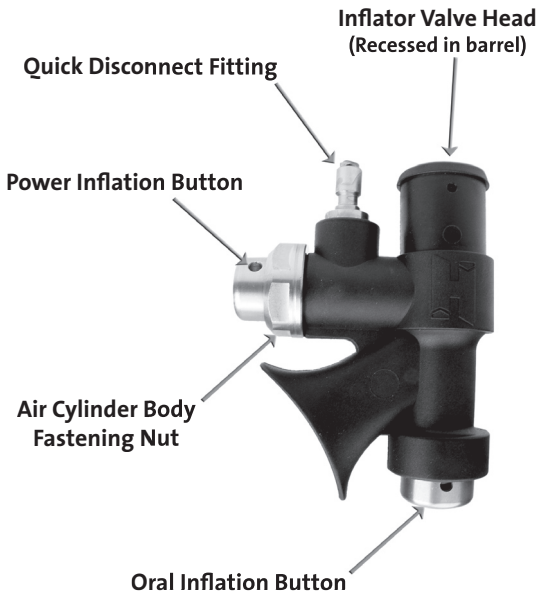

- 1) Separate inflator from the BCD. Halcyon recommends using a new clamp after servicing the inflator.
- 2) Begin disassembly with the oral inflation button by placing the hex key in the “blind hole” recess on the button and using the medium size flat head screwdriver to turn the valve head within the inflator body counter-clockwise. (Figure 3)
- 3) Using adjustable wrench or pliers, grip the small metal notch at the end of the inflator hose quick-disconnect fitting. Turn fitting counter-clockwise until it is removed. (Figure 4)
- 4) Using adjustable wrench or box head wrench, turn the metal air cylinder body fastening nut counter-clockwise until it is removed. (Figure 5)
- 5) Place the hex key in the securing recess on the power inflation button and the small flat head screwdriver in the notch at the end of the valve as shown. Turn counter-clockwise until button is released. (Figure 6)

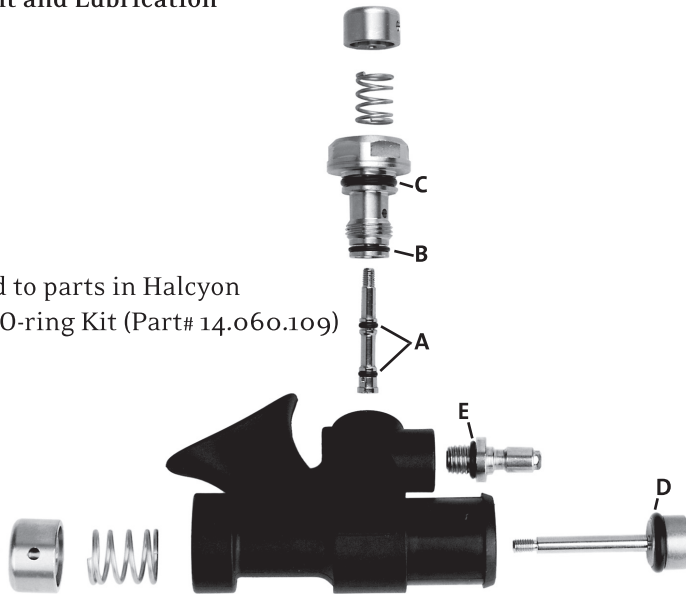

## O-Ring Replacement and Lubrication

Letters correspond to parts in Halcyon Precision Inflator O-ring Kit (Part# 14.060.109)



O-Ring Sizing Guide			
Diagram ID	AS568A Number	Density/Material	Size
A	006	70 durometer polyurethane	
B	012	70 durometer buna	
C	112	70 durometer buna	
D	204	70 durometer buna	
E	011	70 durometer buna	

All O-rings should be replaced during servicing. O-rings can be removed using an O-ring pick. Be sure not to damage the O-ring during installation. All O-rings need to be lubricated with a NSF-61 approved silicone compound lubricant.

All metal parts should be cleaned of dirt and surface rust before re-assembly. Any metal cleaning solution, such as authorized regulator cleaner, can be used.



## Re-assembly

- 1) Place a small dab of releasable threadlocker adhesive on the threaded recess on the power inflation button. (Figure 7) Using the hex key in the “blind hole” recess on the inflation button, slide the valve stem through the inflation valve housing and screw the valve stem into the inflation button with the small flat head screwdriver. Check to make sure spring is seated beneath the button. (Figure 8)
- 2) Screw the inflation valve assembly clockwise into inflator body using adjustable wrench or box head wrench until O-ring is fully seated. Take care not to over tighten. (Figure 9)
- 3) Using adjustable wrench or pliers, screw the inflator hose quick disconnect fitting clockwise into inflator body by gripping the small metal notch at the end. Take care not to over tighten. Proper torque specification is to 12 in·lb (1.4 N·m).
- 4) Place a small dab of threadlocker on the threaded recess of the oral inflate button. Slide dump valve stem into body. Making sure that the spring is in place and using the hex key in the securing recess, screw oral inflation valve head into oral inflation button with the medium size flat head screwdriver.
- 5) Threadlocker compounds must cure for at least 30 minutes, with 24 hours recommended, before underwater use.

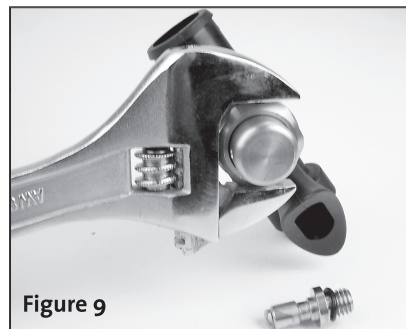
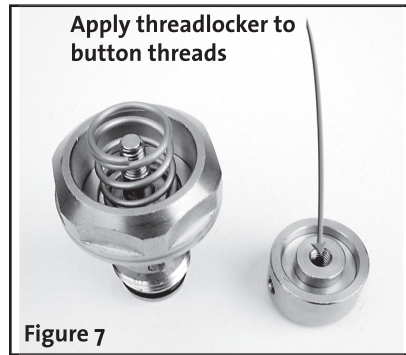

## Troubleshooting

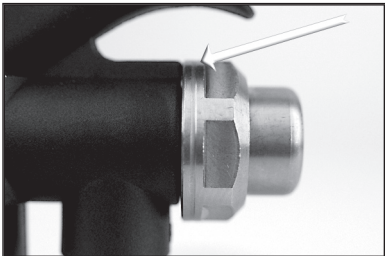
<i>Question</i>	<i>Answer</i>
The power inflation button or dump valve button sticks open?  or The inflator leaks gas into my wing?	Most likely, the inflator is in need of servicing as the O-rings are no longer sufficiently lubricated to travel freely. Also, dirt and debris may have accumulated inside the inflator, interfering with proper operation.
The power inflation button or dump valve button is difficult to depress or is stuck closed?	Most likely, too much threadlocker was used during servicing. Re-servicing the inflator with less threadlocker should restore the buttons' function. Also dirt and debris may have accumulated inside the inflator and interfered with its function. Servicing should resolve this issue.
My inflator hose will not fully seat on the inflator hose fitting or leaks when connected?	Check the O-ring in the fitting of your inflator hose. This O-ring will eventually wear out under use and may be in need of replacement. Dirt and debris can accumulate inside the coupling to the inflator hose. Cleaning this coupling out may help retain a solid seal.
Gas blows out the inflation button when I inflate my BCD?	Most likely, the "C" O-ring has been damaged and in need of replacement.
Do I have the most recent version of the Halcyon Precision Inflator on my BC?	Current inflators have NPB as part of their serial number engraved on the plastic inflator body. The second-generation production run of Halcyon inflators has a slight groove along the air cylinder body fastening nut. If your inflator's mechanism is not marked with a groove, return it to your local Halcyon dealer or contact <a href="mailto:techservices@halcyon.net">techservices@halcyon.net</a> to arrange for a replacement. The previous version of the inflator has been recalled.  



1110 S. Main Street • High Springs, FL • 32643  
[www.halcyon.net](http://www.halcyon.net) • [info@halcyon.net](mailto:info@halcyon.net)